

CYLINDER CRANKCASE 2

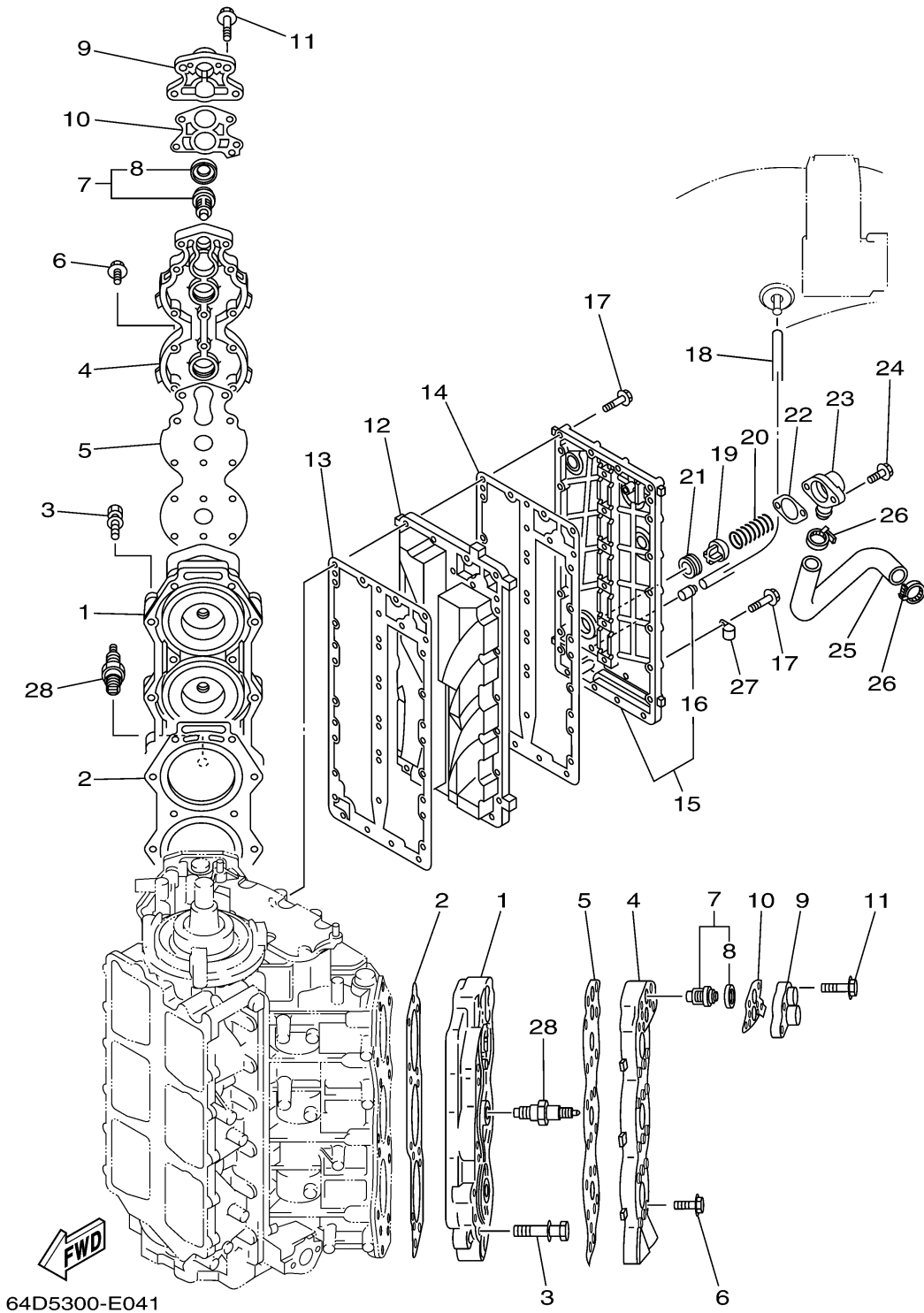

Ref No.	Part Number	Description	Qty	Remarks
1	6G5-11111-04-1S	HEAD, CYLINDER 1	2	
2	6G5-11181-A3-00	.GASKET, CYLINDER HEAD 1	2	
3	90119-08MA8-00	BOLT, WITH WASHER	28	
4	6G5-11191-00-1S	COVER, CYLINDER HEAD 1	2	
5	6G5-11193-A2-00	.GASKET, HEAD COVER 1	2	
6	90119-06MA4-00	BOLT, WITH WASHER	36	
7	6E5-12411-30-00	THERMOSTAT	2	
8	688-12412-00-00	.SEAL, THERMOSTAT	1	
9	688-12413-00-1S	COVER, THERMOSTAT	2	
10	688-12414-A1-00	.GASKET, COVER	2	
11	90119-06MA6-00	BOLT, WITH WASHER	8	
12	64D-41111-00-1S	INNER COVER, EXHAUST	1	
13	6G5-41112-A1-00	GASKET, EXHAUST INNER COVER	1	
14	6G5-41114-A0-00	.GASKET, EXHAUST OUTER COVER	1	
15	6R3-41113-00-1S	OUTER COVER, EXHAUST	1	
16	650-24378-00-00	.PIPE, JOINT 4	1	
17	90119-06MA5-00	BOLT, WITH WASHER	29	
18	90445-09097-00	HOSE (L250)	1	
19	60H-12416-00-00	VALVE, PRESSURE CONTROL	1	
20	90501-16M11-00	SPRING, COMPRESSION	1	

CONTINUED ON NEXT FRAME >

CYLINDER CRANKCASE 2

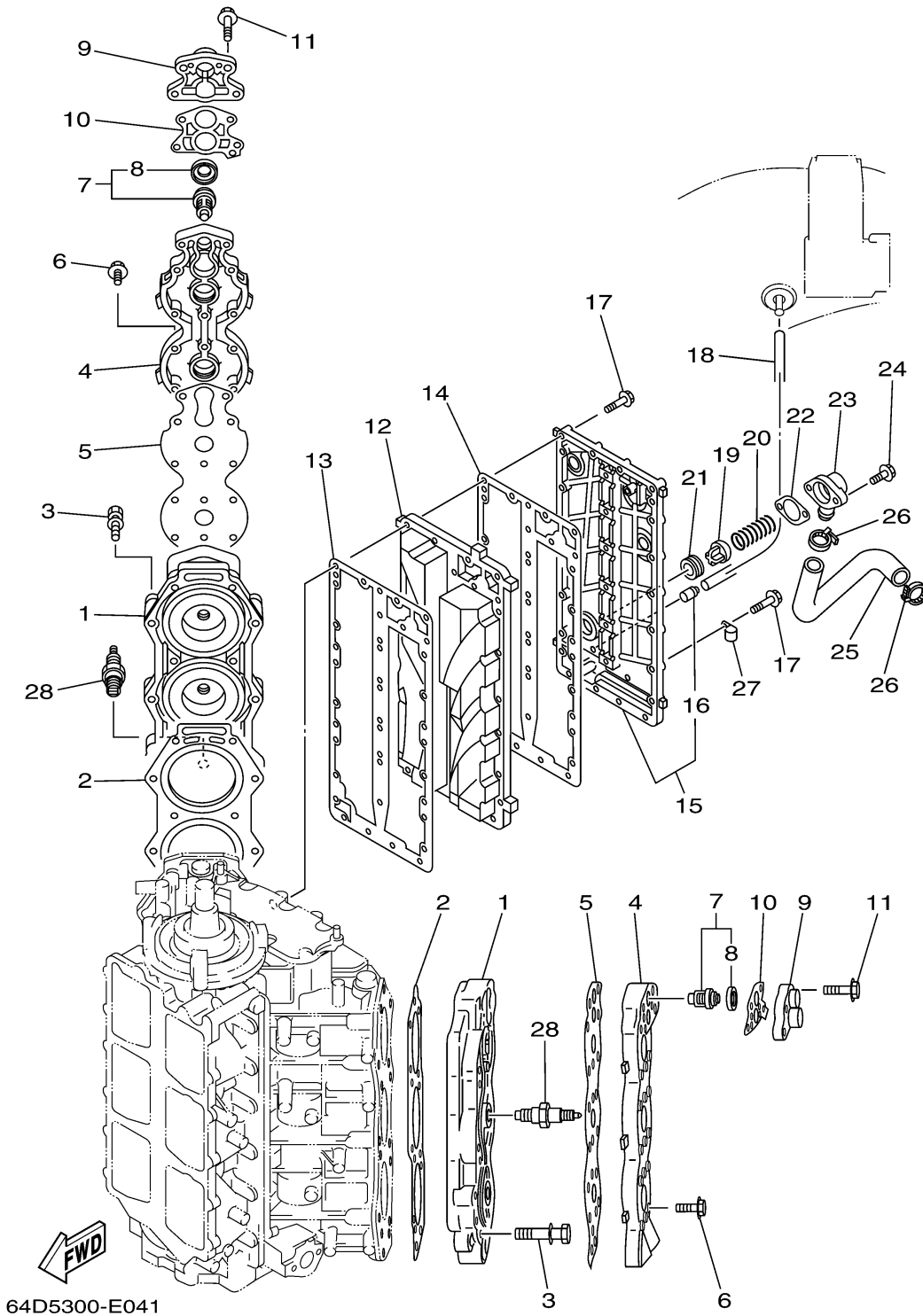

Ref No.	Part Number	Description	Qty	Remarks
21	90480-20M05-00	GROMMET	1	
22	6G5-11382-A1-00	.GASKET 2	1	
23	6G5-11372-00-1S	COVER, BYPASS 2	1	
24	97595-06420-00	BOLT, WITH WASHER	2	
25	6G5-12576-00-00	HOSE 1	1	
26	90465-13M18-00	CLAMP	2	
27	90465-06M86-00	CLAMP	2	
28	NGK-BR7HS-10-00	PLUG, SPARK (NGK BR7HS-10)	6	