

CYLINDER CRANKCASE 1

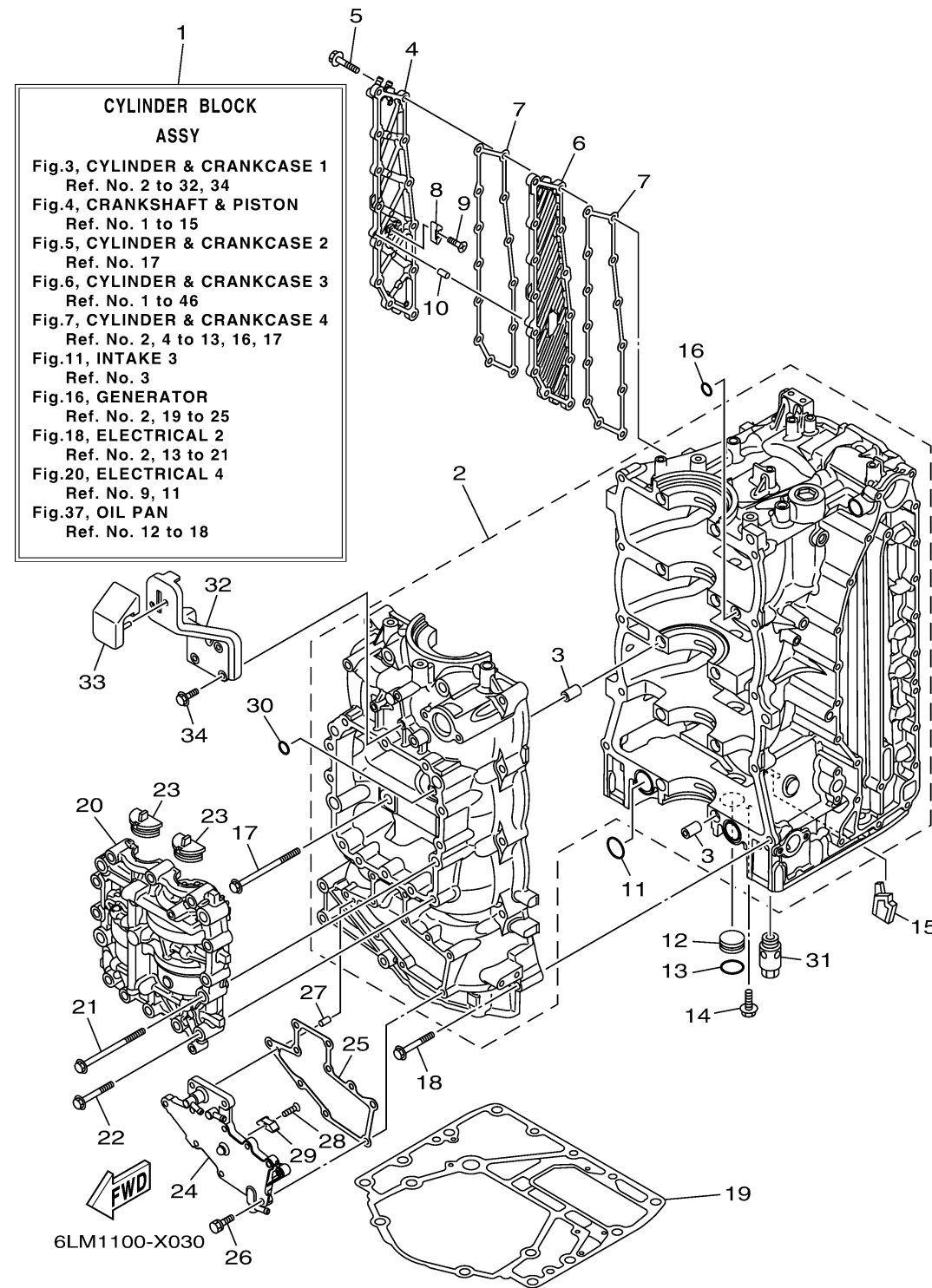

Ref No.	Part Number	Description	Qty	Remarks
1	6DA-W009B-17-9S	CYLINDER BLOCK ASSY	1	
2	6DA-15109-01-9S	CRANKCASE ASSY	1	
3	91814-18002-00	.PIN, DOWEL	10	
4	6DA-15414-00-9S	COVER 1	1	
5	90105-06028-00	BOLT, FLANGE	13	
6	6DA-15423-00-9S	COVER 2	1	
7	6DA-15353-01-00	.GASKET, DRAIN	2	
8	6E5-11325-00-00	ANODE	1	
9	98780-04016-00	SCREW, FLAT HEAD	1	
10	91690-40010-00	PIN, SPRING	1	
11	93210-25552-00	.O-RING	2	
12	90338-25004-00	PLUG	1	
13	93210-25647-00	.O-RING	1	
14	90119-06276-00	BOLT, WITH WASHER	1	
15	6DA-14664-01-00	.GROMMET, WATER SHUT	1	
16	93210-12648-00	.O-RING	1	
17	90105-10406-00	BOLT, FLANGE	10	
18	90119-08M66-00	BOLT, WITH WASHER	10	
19	63P-11351-04-00	.GASKET, CYLINDER	1	
20	6DA-11500-01-00	BALANCER ASSY	1	

CONTINUED ON NEXT FRAME >

CYLINDER CRANKCASE 1

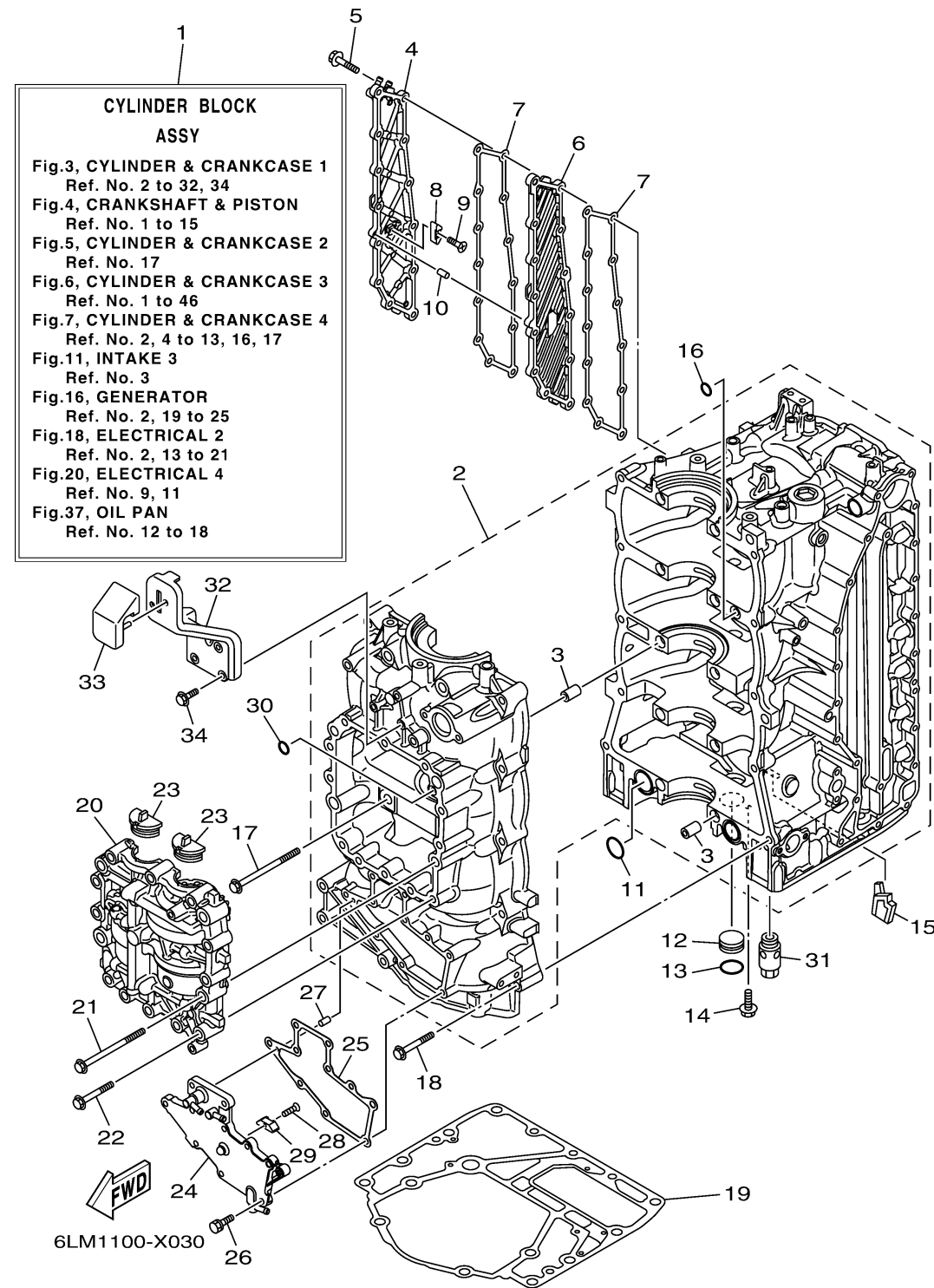

Ref No.	Part Number	Description	Qty	Remarks
21	90105-10406-00	BOLT, FLANGE	4	
22	90105-08175-00	BOLT, FLANGE	12	
23	63P-11512-00-00	SEAL, CRANK COVER	2	
24	6DA-15411-00-9S	COVER, CRANKCASE 1	1	
25	6DA-15451-01-00	.GASKET, CRANKCASE COVER 1	1	
26	90119-06MA3-00	BOLT, WITH WASHER	10	
27	91690-40010-00	PIN, SPRING	1	
28	98780-04016-00	SCREW, FLAT HEAD	1	
29	6E5-11325-00-00	ANODE	1	
30	93210-08001-00	.O-RING	1	
31	63P-13490-00-00	RELIEF VALVE ASSY	1	
32	6DA-42744-00-00	STAY	1	
33	6DA-42662-01-00	DAMPER	1	
34	90105-06039-00	BOLT, FLANGE	3	